

Description

The XPX2N2U8RD uses advanced trench technology to provide excellent $R_{DS(ON)}$, low gate charge and operation with gate voltages as low as 2.5V. This device is suitable for use as a Battery protection or in other Switching application.

 $V_{DS} = 20V, I_D = 80A$
 $R_{DS(ON)} = 2.8m\Omega$ (typ) @ $V_{GS} = 4.5V$
 $R_{DS(ON)} = 4.0m\Omega$ (typ) @ $V_{GS} = 2.5V$
Application

solar road lights

Load switch

Uninterruptible power supply

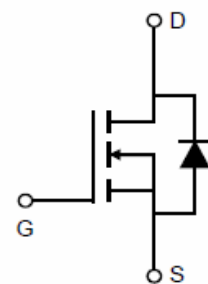
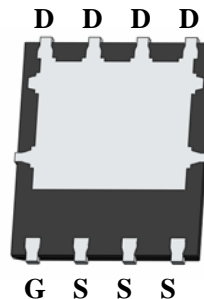
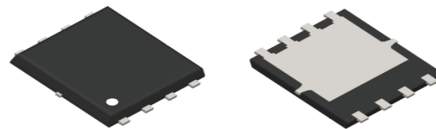
Package Marking and Ordering Information

Product ID	Pack	Marking	Qty(PCS)
XPX2N2U8RD	PDFN5*6-8L	XPX2N2U8RD XXX YYYY	5000

Absolute Maximum Ratings ($T_C = 25^\circ C$ unless otherwise noted)

Symbol	Parameter	Max.	Units
V_{DSS}	Drain-Source Voltage	20	V
V_{GSS}	Gate-Source Voltage	± 12	V
$I_D @ T_C = 25^\circ C$	Continuous Drain Current, $V_{GS} @ 10V^1$	80	A
$I_D @ T_C = 100^\circ C$	Continuous Drain Current, $V_{GS} @ 10V^1$	59	A
IDM	Pulsed Drain Current ^{note1}	360	A
EAS	Single Pulsed Avalanche Energy ^{note2}	110	mJ
P_D	Power Dissipation	81	W
$R_{\theta JA}$	Thermal Resistance, Junction to Case	65	$^\circ C/W$
$R_{\theta JC}$	Thermal Resistance Junction-Case 1	4	$^\circ C/W$
TJ, TSTG	Operating and Storage Temperature Range	-55 to +175	$^\circ C$

Electrical Characteristics (T_J=25 °C, unless otherwise noted)

Symbol	Parameter	Conditions	Min	Typ	Max	Units
BVDSS	Drain-Source Breakdown Voltage	V _{GS} =0V, I _D =250μA	20	24		V
ΔBVDSS/ΔTJ	BVDSS Temperature Coefficient	Reference to 25°C, I _D =1mA	---	0.018	---	V/°C
VGS(th)	Gate Threshold Voltage	V _{DS} =V _{GS} , I _D =250μA	0.50	0.65	1.0	V
RDS(ON)	Static Drain-Source On-Resistance	V _{GS} =4.5V, I _D =30A		2.8	4.0	mΩ
RDS(ON)	Static Drain-Source On-Resistance	V _{GS} =2.5V, I _D =20A		4.0	6.0	
IDSS	Zero Gate Voltage Drain Current	V _{DS} =20V, V _{GS} =0V			1	μA
IGSS	Gate-Body Leakage Current	V _{GS} =±10V, V _{DS} =0V			±100	nA
C _{iss}	Input Capacitance	V _{DS} =10V, V _{GS} =0V, f=1MHZ		3200		pF
C _{oss}	Output Capacitance			460		
C _{rss}	Reverse Transfer Capacitance			446		
Q _g	Total Gate Charge	V _{GS} =4.5V, V _{DS} =10V, I _D =30A		11.05		nC
Q _{gs}	Gate-Source Charge			1.73		
Q _{gd}	Gate-Drain Charge			3.1		
tD(on)	Turn-on Delay Time	V _{GS} =4.5V, V _{DS} =10V, I _D =30A R _{GEN} =1.8Ω		9.7		ns
t _r	Turn-on Rise Time			37		
tD(off)	Turn-off Delay Time			63		
t _f	Turn-off fall Time			52		
V _{SD}	Diode Forward Voltage	I _S =7.6A, V _{GS} =0V			1.2	V

Note :

- 1、 The data tested by surface mounted on a 1 inch² FR-4 board with 2OZ copper.
- 2、 The data tested by pulsed , pulse width ≅ 300us , duty cycle ≅ 2%
- 3、 The power dissipation is limited by 150°C junction temperature
- 4、 The data is theoretically the same as I_D and I_{DM} , in real applications , should be limited by total power dissipation.
- 5、 EAS condition: T_J=25°C, V_{DD}=15V, V_G=4.5V, R_G=25Ω, L=0.5mH, I_{AS}=21A

Typical Characteristics

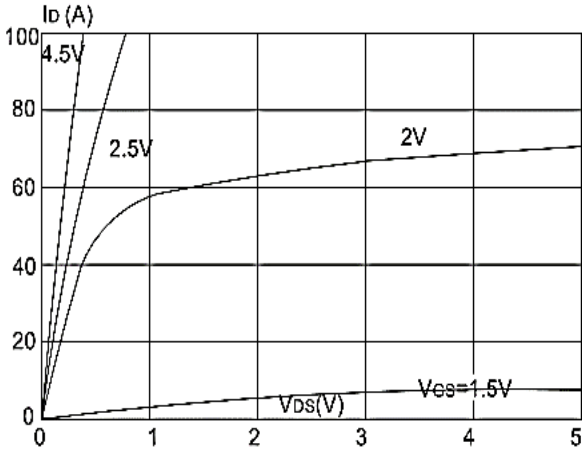

Figure 1: Output Characteristics

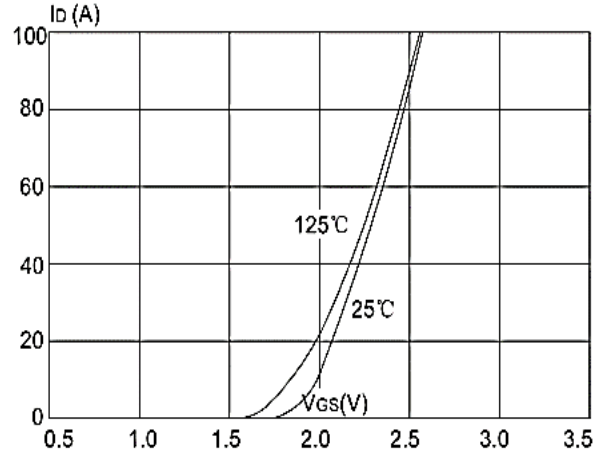

Figure 2: Typical Transfer Characteristics

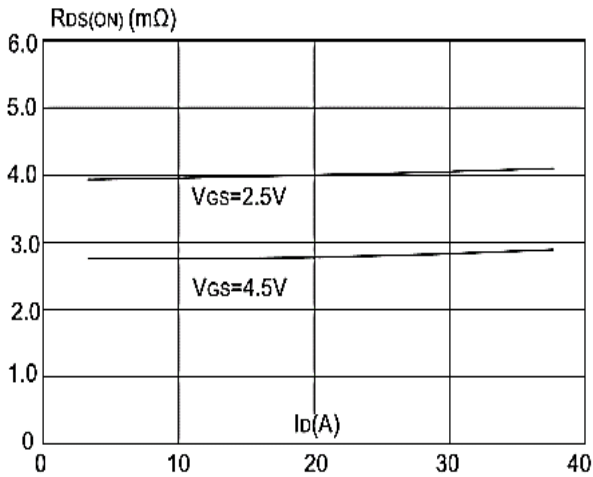

Figure 3: On-resistance vs. Drain Current

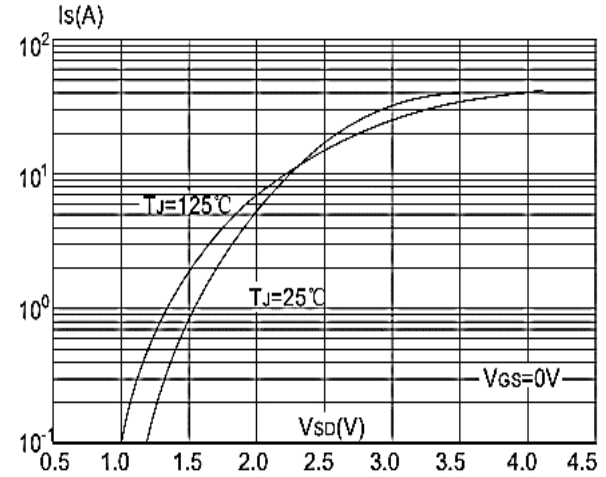

Figure 4: Body Diode Characteristics

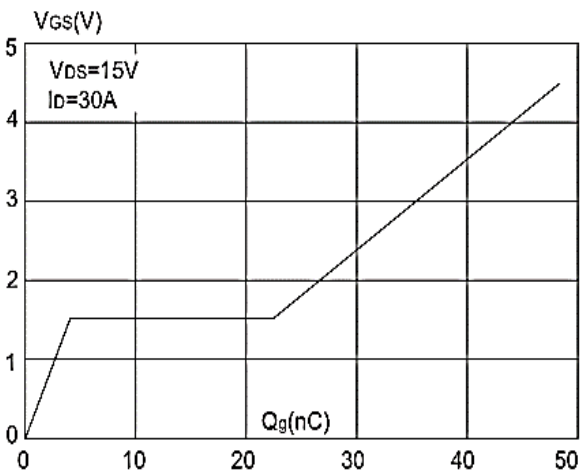

Figure 5: Gate Charge Characteristics

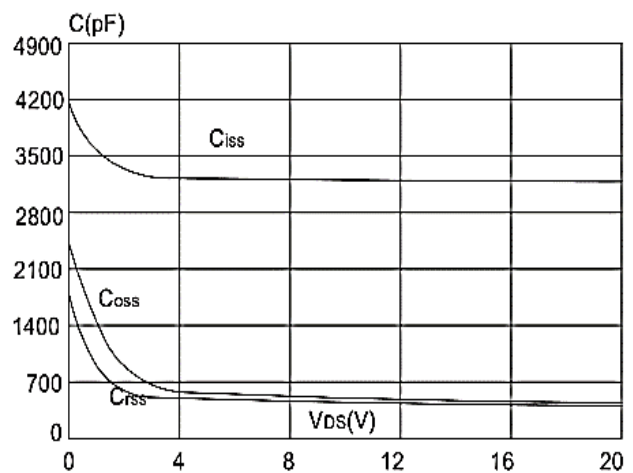

Figure 6: Capacitance Characteristics

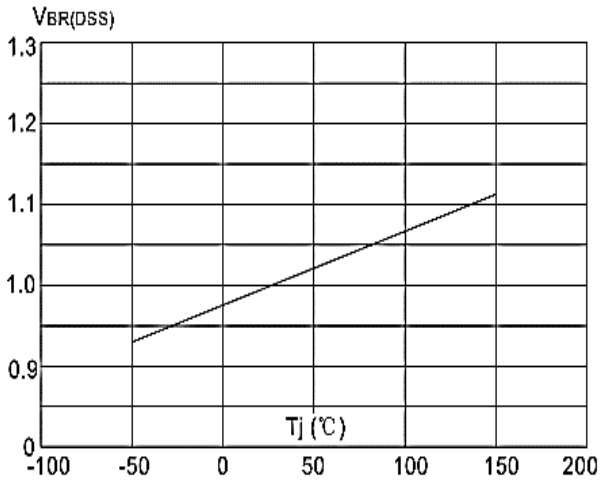

Figure 7: Normalized Breakdown Voltage vs Junction Temperature

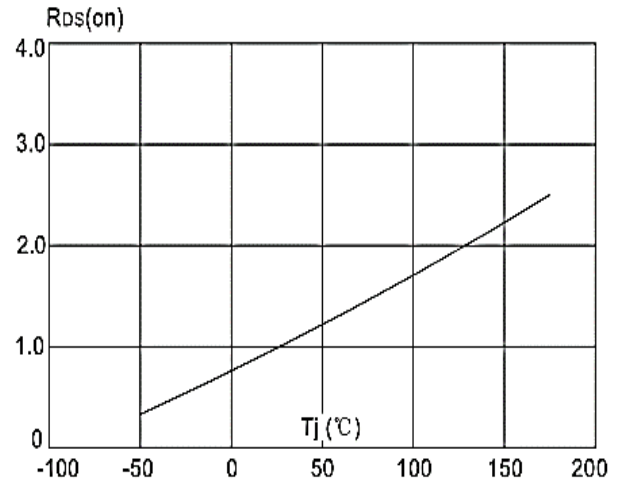

Figure 8: Normalized on Resistance vs. Junction Temperature

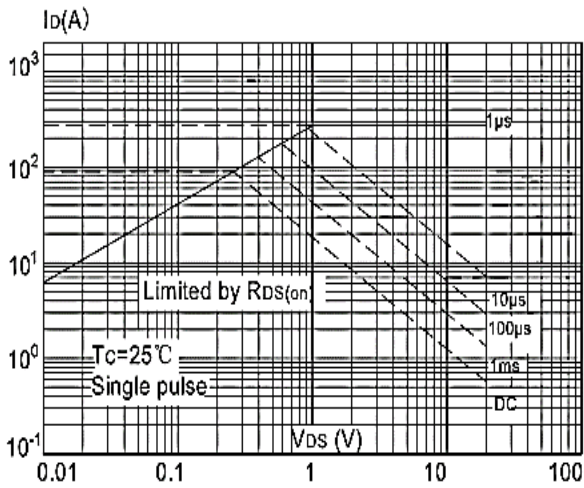

Figure 9: Maximum Safe Operating Area

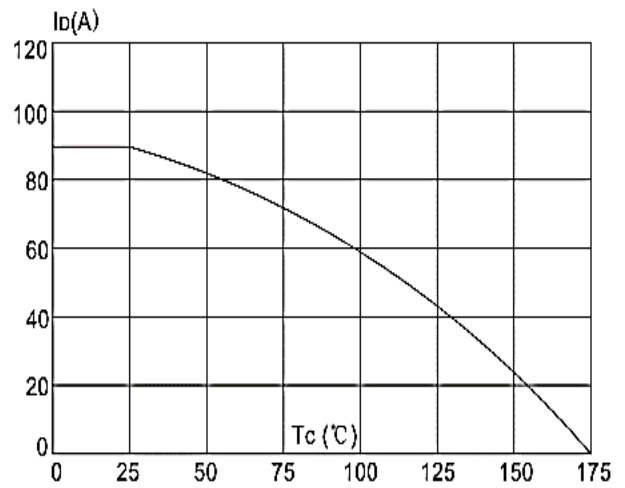

Figure 10: Maximum Continuous Drain Current vs. Ambient Temperature

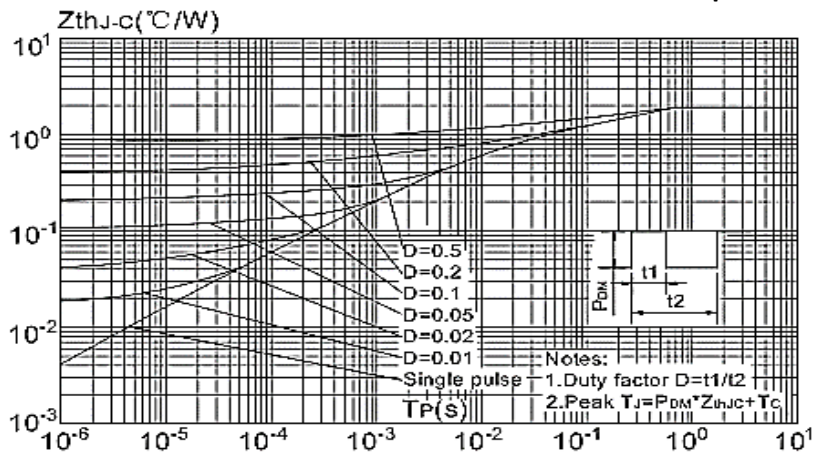
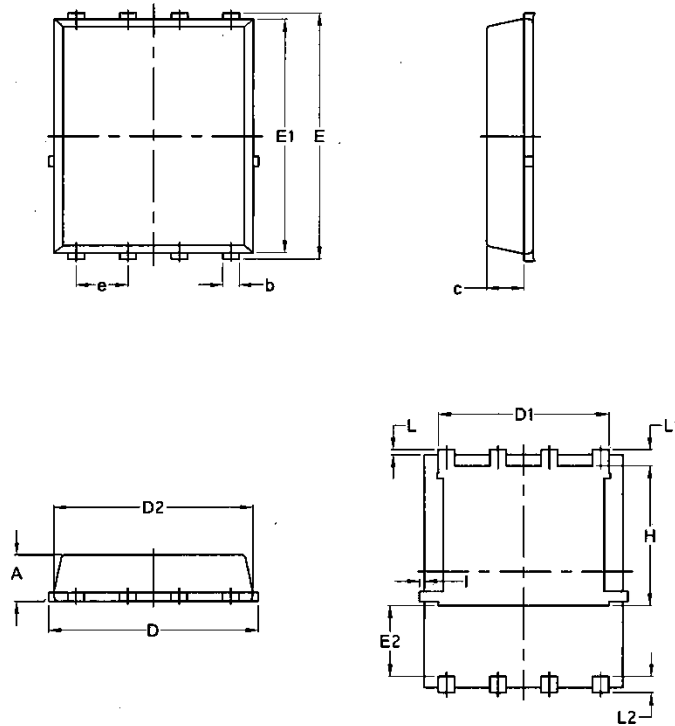

Figure.11: Maximum Effective Transient Thermal Impedance, Junction-to-Ambien

Package Mechanical Data-DFN5*6-8L-JQ Single

Symbol	Common			
	mm		Inch	
	Min	Max	Min	Max
A	1.03	1.17	0.0406	0.0461
b	0.34	0.48	0.0134	0.0189
c	0.824	0.0970	0.0324	0.082
D	4.80	5.40	0.1890	0.2126
D1	4.11	4.31	0.1618	0.1697
D2	4.80	5.00	0.1890	0.1969
E	5.95	6.15	0.2343	0.2421
E1	5.65	5.85	0.2224	0.2303
E2	1.60	/	0.0630	/
e	1.27 BSC		0.05 BSC	
L	0.05	0.25	0.0020	0.0098
L1	0.38	0.50	0.0150	0.0197
L2	0.38	0.50	0.0150	0.0197
H	3.30	3.50	0.1299	0.1378
I	/	0.18	/	0.0070

Flow (wave) soldering (solder dipping)

Product	Peak Temperature	Dipping Time
Pb device	245°C ±5°C	5sec ±1 sec
Pb-Free device	260°C +0/-5°C	5sec ±1 sec



This integrated circuit can be damaged by ESD. UniverChip Corporation recommends that all integrated circuits be handled with appropriate precautions. Failure to observe proper handling and installation procedure can cause damage. ESD damage can range from subtle performance degradation to complete device failure. Precision integrated circuits may be more susceptible to damage because very small parametric changes could cause the device not to meet its published specifications.

Attention:

- Any and all XPX power products described or contained herein do not have specifications that can handle applications that require extremely high levels of reliability, such as life-support systems, aircraft's control systems, or other applications whose failure can be reasonably expected to result in serious physical and/or material damage. Consult with your XPX power representative nearest you before using any XPX power products described or contained herein in such applications.
- XPX power assumes no responsibility for equipment failures that result from using products at values that exceed, even momentarily, rated values (such as maximum ratings, operating condition ranges, or other parameters) listed in products specifications of any and all XPX power products described or contained herein.
- Specifications of any and all XPX power products described or contained herein stipulate the performance, characteristics, and functions of the described products in the independent state, and are not guarantees of the performance, characteristics, and functions of the described products as mounted in the customer's products or equipment. To verify symptoms and states that cannot be evaluated in an independent device, the customer should always evaluate and test devices mounted in the customer's products or equipment.
- XPX power Semiconductor CO.,LTD. strives to supply high-quality high-reliability products. However, any and all semiconductor products fail with some probability. It is possible that these probabilistic failures could give rise to accidents or events that could endanger human lives, that could give rise to smoke or fire, or that could cause damage to other property. When designing equipment, adopt safety measures so that these kinds of accidents or events cannot occur. Such measures include but are not limited to protective circuits and error prevention circuits for safe design, redundant design, and structural design.
- In the event that any or all XPX power products(including technical data, services) described or contained herein are controlled under any of applicable local export control laws and regulations, such products must not be exported without obtaining the export license from the authorities concerned in accordance with the above law.
- No part of this publication may be reproduced or transmitted in any form or by any means, electronic or mechanical, including photocopying and recording, or any information storage or retrieval system, or otherwise, without the prior written permission of XPX power Semiconductor CO.,LTD.
- Information (including circuit diagrams and circuit parameters) herein is for example only ; it is not guaranteed for volume production. XPX power believes information herein is accurate and reliable, but no guarantees are made or implied regarding its use or any infringements of intellectual property rights or other rights of third parties.
- Any and all information described or contained herein are subject to change without notice due to product/ technology improvement, etc. When designing equipment, refer to the "Delivery Specification" for the XPX power product that you intend to use.
- This catalog provides information as of Sep.2019. Specifications and information herein are subject to change without notice.